

# Original Operating Manual

## Snow plow SRM-VP 130/160



### Table of contents

<b>1</b>	<b>About this operating manual</b> .....	<b>3</b>
<b>2</b>	<b>Safety</b> .....	<b>4</b>
2.1	Intended use .....	4
2.2	Qualification of personnel.....	4
2.3	General safety instructions.....	5
2.4	Special safety instructions.....	5
<b>3</b>	<b>Mounting the snow plow</b> .....	<b>7</b>
3.1	Adjusting the height of the coupling triangle on the snow plow.....	7
3.2	Mount the snow plow on the tractor.....	8
<b>4</b>	<b>Operation</b> .....	<b>9</b>
4.1	Settings on the snow plow.....	9
4.1.1	Adjusting the support wheel .....	9
4.2	Working with the different blade variants.....	10
<b>5</b>	<b>Maintenance</b> .....	<b>11</b>
5.1	General.....	11
5.2	Service.....	11
5.2.1	Maintenance after 25 operating hours or after a longer standstill period.....	11
5.2.2	Faults.....	11
5.3	Adjusting the pendulum compensation.....	11
5.4	Repair .....	13
<b>6</b>	<b>Disposal</b> .....	<b>13</b>
<b>7</b>	<b>Warranty</b> .....	<b>13</b>
<b>8</b>	<b>Technical data and accessories</b> .....	<b>14</b>
8.1	Technical data.....	14
8.2	Accessories .....	14
<b>9</b>	<b>List of illustrations</b> .....	<b>15</b>
<b>10</b>	<b>EC Declaration of Conformity</b> .....	<b>16</b>

## 1 About this operating manual

Dear customer!

Thank you for purchasing this device, we appreciate your trust.

In order to optimally use your new snow plow it is necessary to read this operating manual completely and conscientiously and to understand it before first use.

To obtain the long service life that matev products are known for, careful and conscientious maintenance is a strict requirement. To properly maintain your snow plow it is strictly necessary that you have carefully read this operating manual. Moreover it is not possible for matev to assume liability for damage that is attributed to improper use or non-intended use of the snow plow.

Keep this operating manual where it is easily accessible. This will enable you to refer to important information and handling instructions as needed.

Listings with bullet points are marked as follows:

- Text
- Text
- Text . . .

Handling instructions are marked in the sequence in which they should be executed, as follows:

1. Text
2. Text
3. Text . . .



**The snow plow is subject to change in the interest of technical progress. All information, illustrations, and technical specifications represent the latest status at the time this manual was published. The manufacturer reserves the right to make changes at any time in the interest of technical progress. However there is no obligation to extend any changes made to previously delivered snow plows or to associated accessories.**

## 2 Safety

Guidelines and instructions with which you must comply are summarized in this section.

Persons who install, operate and maintain the snow plow must have read and understood this operating manual.

### 2.1 Intended use

The snow plow should only be mounted on tractors with sufficient power. It is used for clearing snow on paths, roads, and public areas. Thanks to the pivoting halves of the snow plow, you can switch over from snow plow to conventional snow blade, depending on the implementation conditions. Depending on the condition of the snow the snow plow can be used in snow depths to a maximum of half the blade height. A front power lift with coupling triangle must be mounted on the tractor.



**Attention!**  
**Do not use the snow plow for grading tasks.**

In addition compliance with the service and maintenance guidelines is a component of intended use. Moreover intended use includes exclusive use of original spare parts and supplemental equipment, or use of such parts and equipment that meet the technical requirements specified by the manufacturer.

All other uses are excluded.

Non-intended use causes:

- Health hazards for the operator or for third parties
- Damage to the tractor and the attachments
- Environmental damage
- This will immediately invalidate the guarantee.

To avoid accidents and reduce the risk of accidents the relevant accident prevention regulations and the other generally acknowledged occupational health and safety and road traffic regulations apply without limitation.

Changes to the snow plow and/or the associated accessories that are not authorized by the manufacturer invalidate the guarantee and exclude any liability on the part of the manufacturer for damage due to the changes.

### 2.2 Qualification of personnel

Only persons 18 years of age or older, or instructed persons should install, operate, and maintain the snow plow. The operator must have read and understood this operating manual.

## 2.3 General safety instructions

General safety instructions are explained in this section. These safety instructions are used in the subsequent sections. In addition to the safety aspect, you will save money and work time if you follow these safety instructions.



**Danger!**  
**Severe injury to the operator or third parties occurs.**  
**Follow the safety instruction.**



**Attention!**  
**Minor injury to the operator or third parties can occur. The tractor or the environment can be damaged.**  
**Comply with the safety instruction.**



**Note!**  
**Important, helpful tips or information for the operator.**  
**Read this note. It facilitates your work.**



**Attention!**  
**Injuries can occur.**  
**Wear protective work clothing.**

## 2.4 Special safety instructions

Safety instructions are specified in this chapter that are also affixed as stickers on the implements



**Attention!**  
**Danger of injury due to moving parts.**  
**Remove the ignition key before performing maintenance tasks on the implement.**

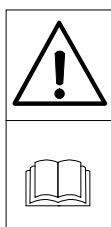

**Attention!**  
**Injuries can occur due to improper operation. The implement can be damaged.**  
**Read the operating manual all the way through.**  
**Comply with the safety instructions.**



**Attention!**  
Injuries due to fluid escaping under high pressure.  
Comply with the instructions in the operating manual.



**Attention!**  
Check all threaded unions prior to using the implement and after using the implement. Loosened connections must be retightened.  
Damage can occur due to loose connections.

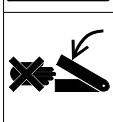

**Attention!**  
Danger of crushing due to moving parts.  
Never reach into the crushing hazard danger area, if parts are still moving or can move.  
Comply with the instruction in the operating manual.

### 3 Mounting the snow plow



**Danger!**  
Severe injury to the operator or third parties occurs.  
Switch off the tractor and remove the ignition key before mounting or dismounting the implements.



**Attention!**  
This snow plow is a device with a standard interface that can be attached on virtually any tractor with a cat. 0 coupling triangle.  
Comply with the attachment recommendations in the current price list.



**Note!**  
Enter the chassis number of the front power lift in section , 5.4, on page13 of this operating manual.

#### 3.1 Adjusting the height of the coupling triangle on the snow plow

To better adapt the snow plow to the different tractors, the height of the coupling triangle on the snow plow can be adjusted. Different bores are provided on the coupling triangle of the snow plow for this purpose.



**Note!**  
The coupling triangle is only adjusted the first time the snow plow is mounted.

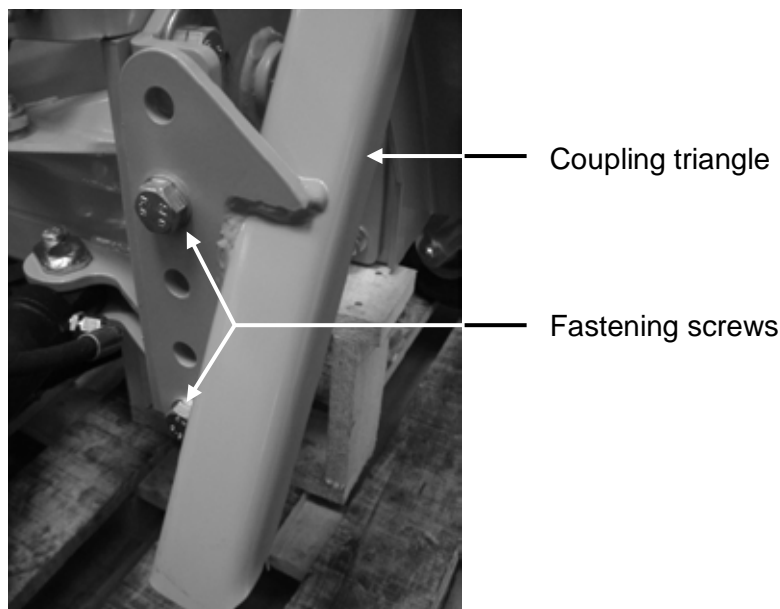

Fig. 1: Height adjustment of the coupling triangle

1. Unscrew all M16 fastening screws on the coupling triangle.
2. Dismount the coupling triangle from the snow plow.
3. Mount the coupling triangle at the required height on the snow plow.
4. Tighten all four screws.

### 3.2 Mount the snow plow on the tractor

#### **Preparations on the snow plow:**

Prior to coupling the snow plow on the tractor the lock bolt must be unlocked.

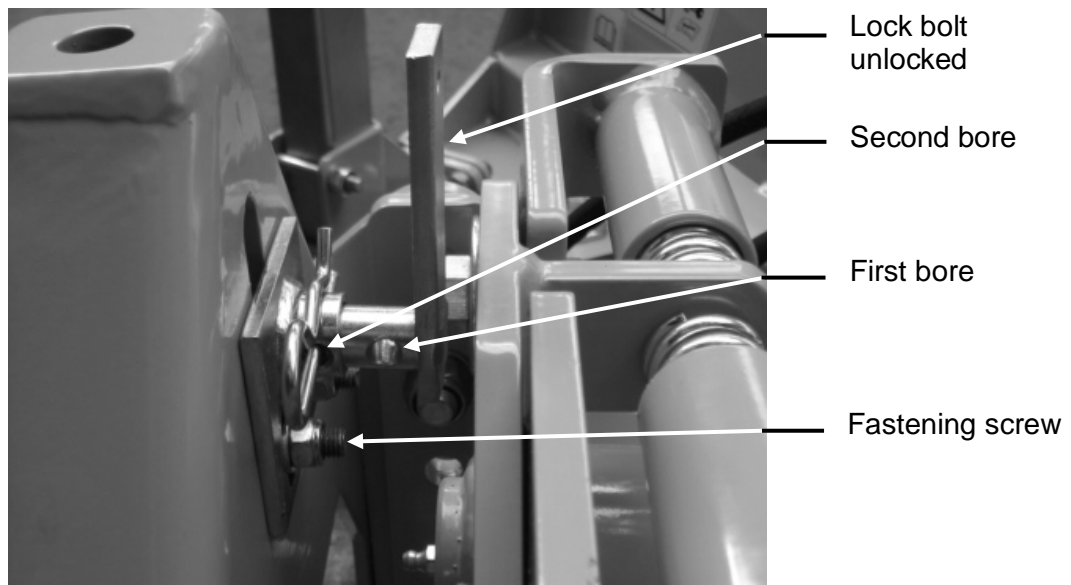

Fig. 2: Lock bolt

1. Remove the spring cotter pin.
2. Pull the lock bolt out to the second bore.
3. Secure the lock bolt with the spring cotter pin as shown in Fig. 2

#### **Coupling the snow plow:**

1. Drive the tractor toward the snow plow until the coupling triangle of the tractor is under the coupling triangle of the snow plow.
2. Lift the front power lift of the tractor until the coupling triangle of the snow plow hangs on the coupling triangle of the tractor.
3. Push the lock bolt in to the first bore.

#### **Note!**

&

**Handling instructions 4 to 6 are only required for the first mounting, or when coupling on another type of tractor.**

4. Unscrew the fastening screws (see Fig. 1).
5. Slide the base plate with the lock bolt upward until the lock bolt strikes the coupling triangle of the tractor.
6. Tighten the fastening screws.
7. Connect the hydraulic hoses to the front coupling of the tractor's hydraulic lift.



## 4 Operation



**Attention!**

**Before starting up the implement read the instructions on safety and handling for operation of the entire implement and connection to the tractor.**

The snow plow is fastened to the quick-coupling triangle in the front implement of the tractor. The two halves of the snow plow are operated from the driver's seat of the tractor with one hydraulic cylinder for each half. In this process you switch between the two blade halves with a electromagnetic changeover valve. The implement is equipped with spring flaps for the safety of the driver and to protect the snow plow.



**Attention!**

**The snow plow should not be charged with downward pressure via the tractor's hydraulic system! When plowing snow the tractor hydraulic system must be switched to the float setting!**

### 4.1 Settings on the snow plow



**Danger!**

**Severe injury to the operator or third parties occurs.**

**Switch off the tractor and remove the ignition key before making any settings on the snow plow.**

**Safeguard the snow plow against falling with suitable aids, e.g. support frames, mechanical lowering safeguard, etc. on the front power lift.**

#### 4.1.1 Adjusting the support wheel



**Note!**

**Before each use, check the support wheel adjustment. When the snow plow is lowered the support wheels and the scraper bar must touch the ground uniformly.**

1. Lower the snow plow to the ground.
2. Check the support wheel setting.
3. Lift the snow plow and secure it with suitable aids.
4. Switch off the tractor and remove the ignition key.

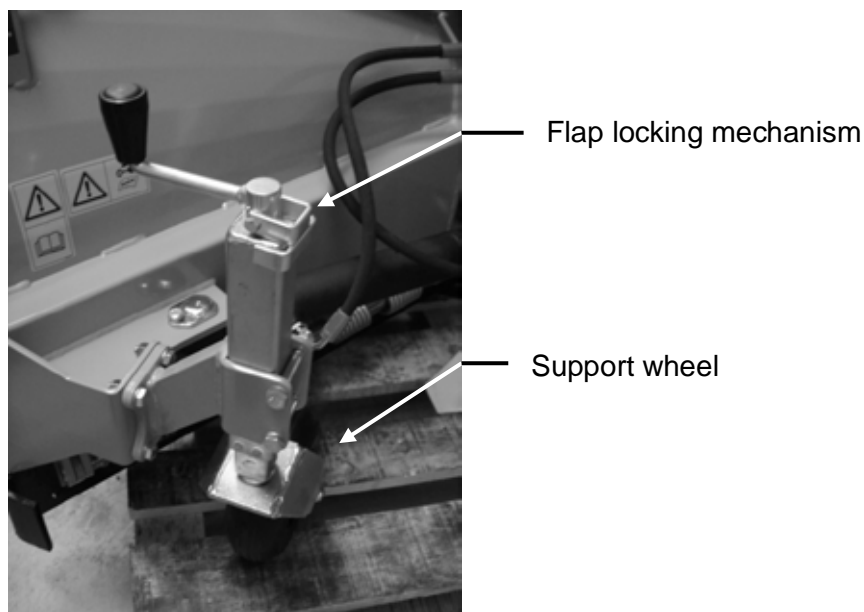

Fig. 3: Support wheel

5. Flip the locking mechanism up.
6. Adjust the desired wheel height with the hand crank.
7. Flip the locking mechanism down.
8. Repeat handling instructions 5 to 7 for the second support wheel.
9. Remove the lowering safeguard.
10. Lower the snow plow to the ground.
11. Recheck the support wheel adjustment.

### 4.2 Working with the different blade variants

&

**Note!**

Depending on snow conditions you can either use the system as a V-snow plow or as a traditional snow blade (straight).

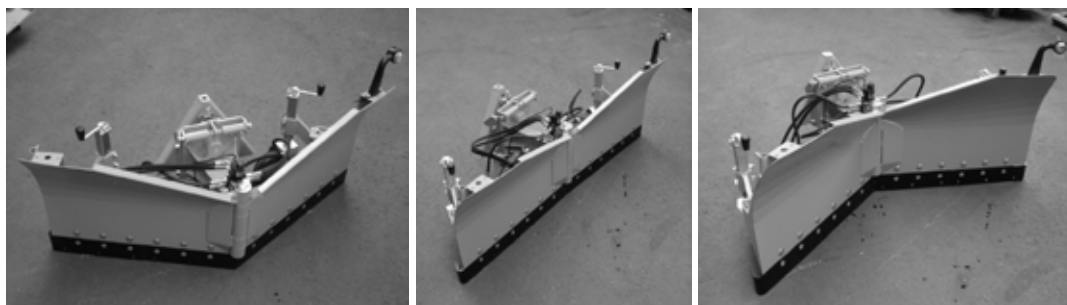

Fig. 4: Snow plow variants

1. Activate the tractor's hydraulic system to swing one side of the blade.
2. Switch over the electromagnetic valve.
3. Activate the tractor's hydraulic system to swing the other side of the blade.

## 5 Maintenance

### 5.1 General



**Attention!**

**Personal injury or damage to the tractor and the implements can occur. Before each use of the implements check all safety-relevant parts and the hydraulic connections.**

### 5.2 Service

- Retighten all screws after the first use of the implement.
- Before each use, check all safety parts and fastening parts.
- Before each use, check the scraper bars for wear and replace them if needed.

#### 5.2.1 Maintenance after 25 operating hours or after a longer standstill period

At regular intervals, and always at the beginning and end of the season, the moving parts of the implement must be greased or oiled.

If there is no lubricating nipple on moving parts, then the area must be greased with a brush or lubricated with oil.

Check all connecting screws for firm seat, and tighten loose screws.

#### 5.2.2 Faults

Fault	Possible cause / correction
Only one blade half can move.	The electromagnetic valve is not functioning, check the electrical connections.
Spring flaps fold to the rear too easily.	Check whether individual springs on the spring flaps are defective and replace the defective springs.
Scraper bars do not show uniform wear.	Check the adjustment of the support wheels. Check the spring adjustment on the pendulum compensation.

### 5.3 Adjusting the pendulum compensation

If the blade plate is not aligned after lifting, it may be the case that the springs of the pendulum compensation are not set uniformly or are too weak.

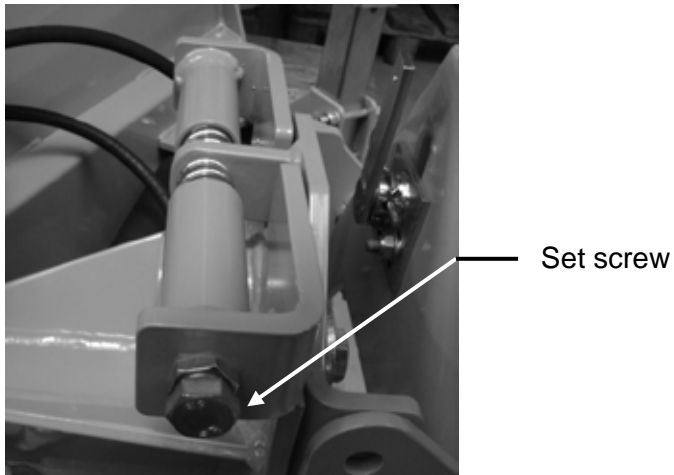

Fig. 5: Springs of the pendulum compensation

1. Check the tension of the left and right springs.
2. Re-tension the weaker springs so that both springs have approximately the same tension.

5.4 Repair

If there are faults, problems, or other indications of malfunction, contact your sales consultant or directly contact the manufacturer:

matev GmbH  
Nürnberger Str. 50  
90579 Langenzenn  
Tel.: (Switchboard): 09 101/90 87-0

Enter the article number and the chassis number here.  
This information is on the type plate of the implement.

Article number: .....

chassis number .....

6 Disposal

The implements must be disposed of in accordance with the applicable regulations of the municipality or the country.

Take the parts to the collection points for residual waste, special waste, or recycle them depending on material.

matev GmbH does not provide any disposal services.

7 Warranty

The General Terms & Conditions of matev GmbH provide information on the warranty and guarantee conditions.

**matev GmbH**  
**Nürnberger Str. 50**  
**90579 Langenzenn**

8 Technical data and accessories

8.1 Technical data

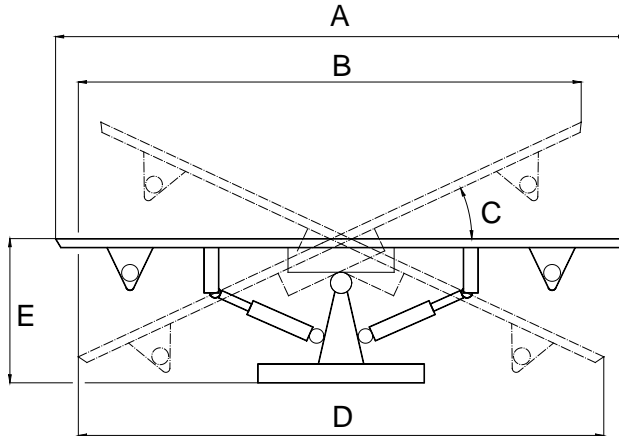

Dimensions	Data - SRM-VP 130 L	Data - SRM-VP 160 L
Clearing width, straight (A)	1300 mm	1640 mm
Cleaning width, angled (B)	1172 mm	1480 mm
Clearing width, V-position (D)	1172 mm	1480 mm
Blade length (E)	550	550 mm
Swing angle (C)	26°	26°
Center height (laterally ascending) with steel scraper bars	520 mm	520 mm
Number of spring flaps	2	4
Weight (without accessories)	150 kg	180 kg

8.2 Accessories

Accessories	Order number
Rubber scraper bar kit SRM-VP 130 L	131_7154
Rubber scraper bar kit SRM-VP 160 L	131_7155
PU scraper bar kit SRM-VP 130 L	131_7156
PU scraper bar kit SRM-VP 160 L	131_7157
Pressure control valve kit	131_7209
Warning flags (set)	131_5632
Side marker lights (set)	131_5634
Adapter cat. I	131_5665

**9 List of illustrations**

Fig. 1: Height adjustment of the coupling triangle .....7  
Fig. 2: Lock bolt .....8  
Fig. 3: Support wheel .....10  
Fig. 4: Snow plow variants .....10  
Fig. 5: Springs of the pendulum compensation .....12

## EC Declaration of Conformity

---

### 10 EC Declaration of Conformity

EC Declaration of Conformity for a machine to confirm compliance with the Machinery Directive 2006/42/EC and with the statutory provisions issued for the implementation of the Machinery Directive.

The manufacturer matev GmbH  
Nürnberger Str. 50  
90579 Langenzenn

declares that the machine Snow plow  
SRM-VP 130/160 L  
131 7149 and 131 7150

complies with the provisions of the Machinery Directive 2006/42/EC and with the implementing national statutory provisions.

The signer is authorized to compile the technical documents.

The address is the address of the manufacturer.

Date / Signature March 2010

Name of signer:  
Signer information

.....  
Georg Hemmerlein  
Managing Director

